

High temperature sensor-KM12

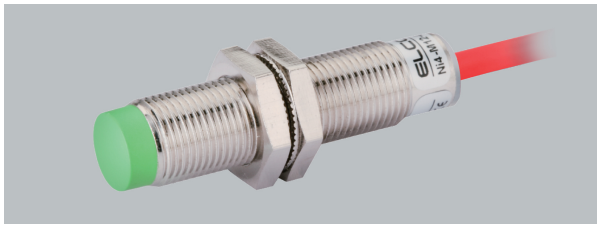

- Stainless steel housing
- Threaded cylindrical housing
- Temperature-resistant up to 120°C
- IP67
- High-brightness LED indicator

Technical Data

Type	Rated Operating Distance S_n	Mounting	Output	Voltage Range U_B	Rated Current	Switching Frequency	Ambient Temperature	Connection	Fig
Fi2-KM12-OD6L/T120	2mm	Flush	DC NO	10...30VDC	≤100mA	1000Hz	-25...120°C	2m cable	Fig.1
Fi2-KM12-CD6L/T120	2mm	Flush	DC NC	10...30VDC	≤100mA	1000Hz	-25...120°C	2m cable	Fig.1
Ni4-KM12-OD6L/T120	4mm	Non-flush	DC NO	10...30VDC	≤100mA	800Hz	-25...120°C	2m cable	Fig.2
Ni4-KM12-CD6L/T120	4mm	Non-flush	DC NC	10...30VDC	≤100mA	800Hz	-25...120°C	2m cable	Fig.2
Fi2-KM12-OP6L/T120	2mm	Flush	PNP NO	10...30VDC	≤100mA	1000Hz	-25...120°C	2m cable	Fig.1
Fi2-KM12-CP6L/T120	2mm	Flush	PNP NC	10...30VDC	≤100mA	1000Hz	-25...120°C	2m cable	Fig.1
Fi2-KM12-ON6L/T120	2mm	Flush	NPN NO	10...30VDC	≤100mA	1000Hz	-25...120°C	2m cable	Fig.1
Fi2-KM12-CN6L/T120	2mm	Flush	NPN NC	10...30VDC	≤100mA	1000Hz	-25...120°C	2m cable	Fig.1
Ni4-KM12-OP6L/T120	4mm	Non-flush	PNP NO	10...30VDC	≤100mA	800Hz	-25...120°C	2m cable	Fig.2
Ni4-KM12-CP6L/T120	4mm	Non-flush	PNP NC	10...30VDC	≤100mA	800Hz	-25...120°C	2m cable	Fig.2
Ni4-KM12-ON6L/T120	4mm	Non-flush	NPN NO	10...30VDC	≤100mA	800Hz	-25...120°C	2m cable	Fig.2
Ni4-KM12-CN6L/T120	4mm	Non-flush	NPN NC	10...30VDC	≤100mA	800Hz	-25...120°C	2m cable	Fig.2
Fi2-KM12-BP6L/T120	2mm	Flush	PNP NO+NC	10...30VDC	≤100mA	1000Hz	-25...120°C	2m cable	Fig.1
Fi2-KM12-BN6L/T120	2mm	Flush	NPN NO+NC	10...30VDC	≤100mA	1000Hz	-25...120°C	2m cable	Fig.1
Ni4-KM12-BP6L/T120	4mm	Non-flush	PNP NO+NC	10...30VDC	≤100mA	800Hz	-25...120°C	2m cable	Fig.2
Ni4-KM12-BN6L/T120	4mm	Non-flush	NPN NO+NC	10...30VDC	≤100mA	800Hz	-25...120°C	2m cable	Fig.2
Fi2-KM12-OSA3L/T120	2mm	Flush	AC NO	20...250VAC	≤200mA	40Hz	-25...120°C	2m cable	Fig.3
Fi2-KM12-CSA3L/T120	2mm	Flush	AC NC	20...250VAC	≤200mA	40Hz	-25...120°C	2m cable	Fig.3
Ni4-KM12-OSA3L/T120	4mm	Non-flush	AC NO	20...250VAC	≤200mA	40Hz	-25...120°C	2m cable	Fig.4
Ni4-KM12-CSA3L/T120	4mm	Non-flush	AC NC	20...250VAC	≤200mA	40Hz	-25...120°C	2m cable	Fig.4
Fi2-KM12-OA41L/T120	2mm	Flush	DC/AC NO	20...250VAC/DC	DC≤100mA/ AC≤200mA	40Hz	-25...120°C	2m cable	Fig.3
Fi2-KM12-CA41L/T120	2mm	Flush	DC/AC NC	20...250VAC/DC	DC≤100mA/ AC≤200mA	40Hz	-25...120°C	2m cable	Fig.3
Ni4-KM12-OA41L/T120	4mm	Non-flush	DC/AC NO	20...250VAC/DC	DC≤100mA/ AC≤200mA	40Hz	-25...120°C	2m cable	Fig.4
Ni4-KM12-CA41L/T120	4mm	Non-flush	DC/AC NC	20...250VAC/DC	DC≤100mA/ AC≤200mA	40Hz	-25...120°C	2m cable	Fig.4

High temperature sensor-KM12

Dimensions

Fig.1

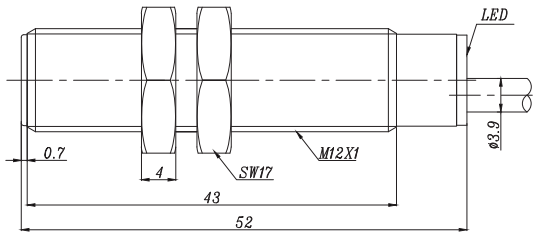

Fig.2

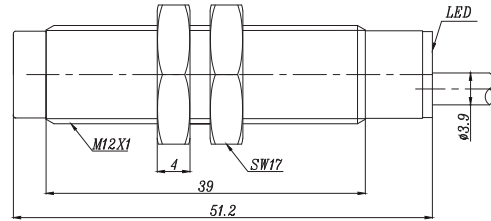

Fig.3

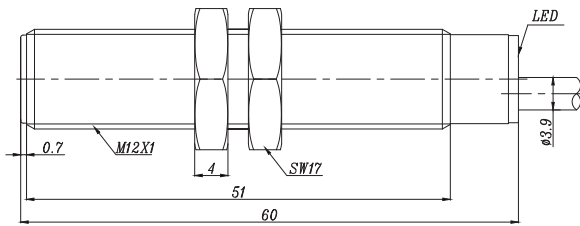
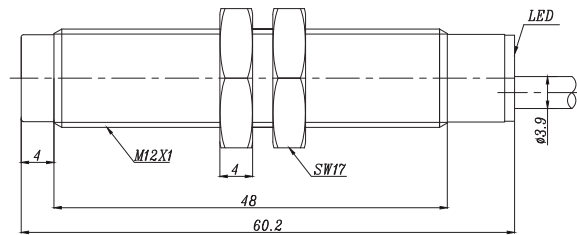
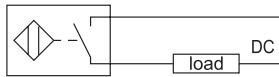

Fig.4



Wiring diagram



DC-2-wire NO

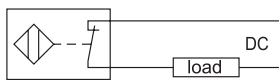

DC-2-wire NC

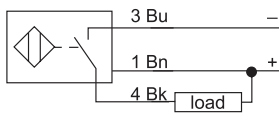

NPN NO

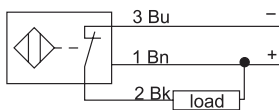

NPN NC

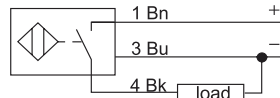

PNP NO

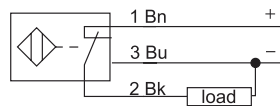

PNP NC

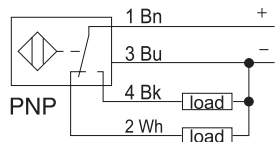

2 NC / 4 NO

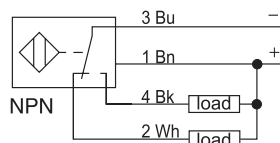

2 NC / 4 NO

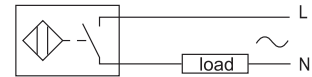

AC-2-wire NO

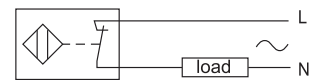

AC-2-wire NC

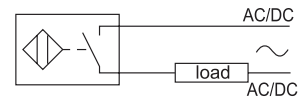

AC/DC-2-wire NO

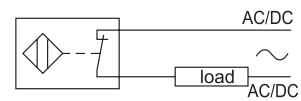

AC/DC-2-wire NC

High temperature sensor-KM12



- Stainless steel housing
- Threaded cylindrical housing
- Temperature-resistant up to 120°C
- IP67
- High-brightness LED indicator

Technical Data

Type	Rated Operating Distance S _n	Mounting	Output	Voltage Range U _B	Rated Current	Switching Frequency	Ambient Temperature	Connection	Fig
Fi2-KM12-OD6L-Q12/T120	2mm	Flush	DC NO	10...30VDC	≤100mA	1000Hz	-25...120°C	M12 Connector	Fig.1
Fi2-KM12-CD6L-Q12/T120	2mm	Flush	DC NC	10...30VDC	≤100mA	1000Hz	-25...120°C	M12 Connector	Fig.1
Ni4-KM12-OD6L-Q12/T120	4mm	Non-flush	DC NO	10...30VDC	≤100mA	800Hz	-25...120°C	M12 Connector	Fig.2
Ni4-KM12-CD6L-Q12/T120	4mm	Non-flush	DC NC	10...30VDC	≤100mA	800Hz	-25...120°C	M12 Connector	Fig.2
Fi2-KM12-OP6L-Q12/T120	2mm	Flush	PNP NO	10...30VDC	≤100mA	1000Hz	-25...120°C	M12 Connector	Fig.1
Fi2-KM12-CP6L-Q12/T120	2mm	Flush	PNP NC	10...30VDC	≤100mA	1000Hz	-25...120°C	M12 Connector	Fig.1
Fi2-KM12-ON6L-Q12/T120	2mm	Flush	NPN NO	10...30VDC	≤100mA	1000Hz	-25...120°C	M12 Connector	Fig.1
Fi2-KM12-CN6L-Q12/T120	2mm	Flush	NPN NC	10...30VDC	≤100mA	1000Hz	-25...120°C	M12 Connector	Fig.1
Ni4-KM12-OP6L-Q12/T120	4mm	Non-flush	PNP NO	10...30VDC	≤100mA	800Hz	-25...120°C	M12 Connector	Fig.2
Ni4-KM12-CP6L-Q12/T120	4mm	Non-flush	PNP NC	10...30VDC	≤100mA	800Hz	-25...120°C	M12 Connector	Fig.2
Ni4-KM12-ON6L-Q12/T120	4mm	Non-flush	NPN NO	10...30VDC	≤100mA	800Hz	-25...120°C	M12 Connector	Fig.2
Ni4-KM12-CN6L-Q12/T120	4mm	Non-flush	NPN NC	10...30VDC	≤100mA	800Hz	-25...120°C	M12 Connector	Fig.2
Fi2-KM12-BP6L-Q12/T120	2mm	Flush	PNP NO+NC	10...30VDC	≤100mA	1000Hz	-25...120°C	M12 Connector	Fig.1
Fi2-KM12-BN6L-Q12/T120	2mm	Flush	NPN NO+NC	10...30VDC	≤100mA	1000Hz	-25...120°C	M12 Connector	Fig.1
Ni4-KM12-BP6L-Q12/T120	4mm	Non-flush	PNP NO+NC	10...30VDC	≤100mA	800Hz	-25...120°C	M12 Connector	Fig.2
Ni4-KM12-BN6L-Q12/T120	4mm	Non-flush	NPN NO+NC	10...30VDC	≤100mA	800Hz	-25...120°C	M12 Connector	Fig.2
Fi2-KM12-OSA3L-Q12/T120	2mm	Flush	AC NO	20...250VAC	≤200mA	40Hz	-25...120°C	M12 Connector	Fig.3
Fi2-KM12-CSA3L-Q12/T120	2mm	Flush	AC NC	20...250VAC	≤200mA	40Hz	-25...120°C	M12 Connector	Fig.3
Ni4-KM12-OSA3L-Q12/T120	4mm	Non-flush	AC NO	20...250VAC	≤200mA	40Hz	-25...120°C	M12 Connector	Fig.4
Ni4-KM12-CSA3L-Q12/T120	4mm	Non-flush	AC NC	20...250VAC	≤200mA	40Hz	-25...120°C	M12 Connector	Fig.4
Fi2-KM12-OA41L-Q12/T120	2mm	Flush	DC/AC NO	20...250VAC/DC	DC≤100mA/ AC≤200mA	40Hz	-25...120°C	M12 Connector	Fig.3
Fi2-KM12-CA41L-Q12/T120	2mm	Flush	DC/AC NC	20...250VAC/DC	DC≤100mA/ AC≤200mA	40Hz	-25...120°C	M12 Connector	Fig.3
Ni4-KM12-OA41L-Q12/T120	4mm	Non-flush	DC/AC NO	20...250VAC/DC	DC≤100mA/ AC≤200mA	40Hz	-25...120°C	M12 Connector	Fig.4
Ni4-KM12-CA41L-Q12/T120	4mm	Non-flush	DC/AC NC	20...250VAC/DC	DC≤100mA/ AC≤200mA	40Hz	-25...120°C	M12 Connector	Fig.4

High temperature sensor-KM12

Dimensions

Fig.1

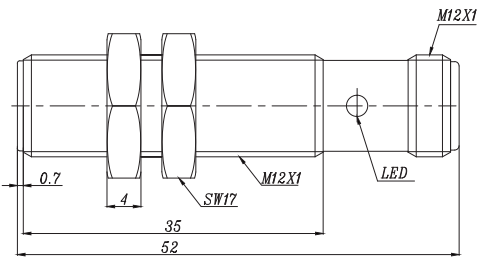

Fig.2

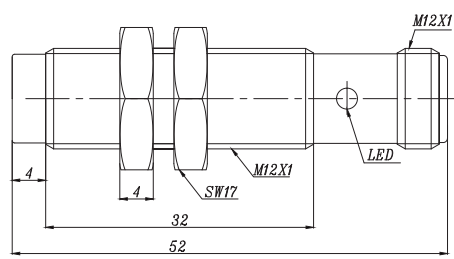

Fig.3

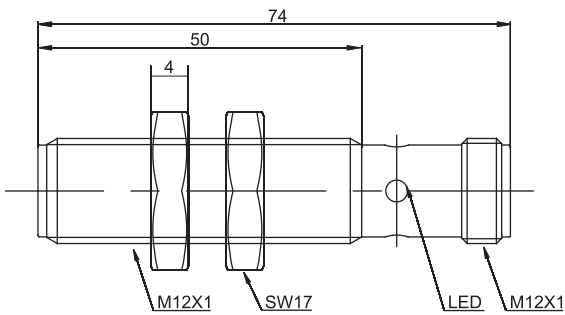
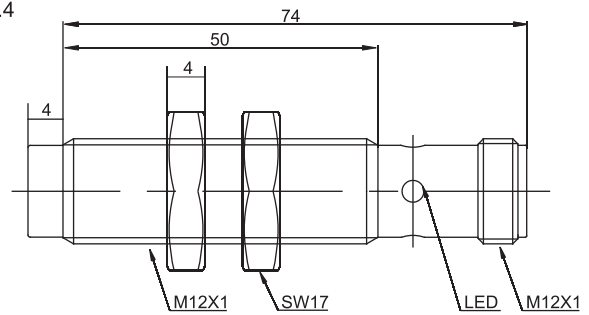
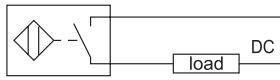

Fig.4



Wiring diagram



DC-2-wire NO

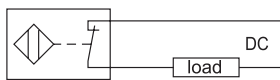

DC-2-wire NC

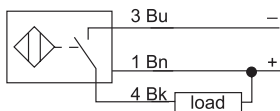

NPN NO

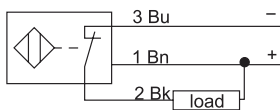

NPN NC

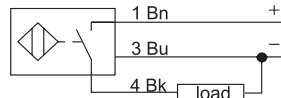

PNP NO

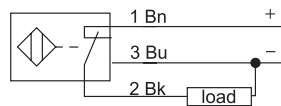

PNP NC

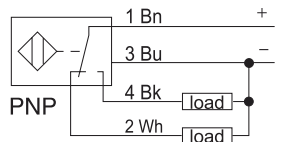

2 NC / 4 NO

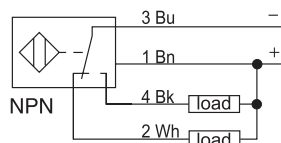

2 NC / 4 NO

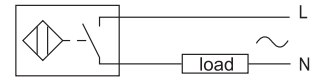

AC-2-wire NO

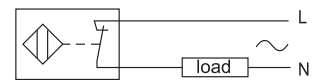

AC-2-wire NC

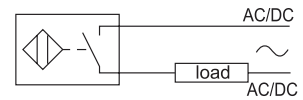

AC/DC-2-wire NO

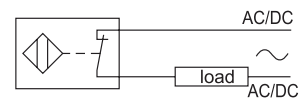

AC/DC-2-wire NC